

Triwer Desk

PERSONALIZZABILE
CUSTOMIZABLE

Moduli triangolari in ALLUMINIO

Triangular modules of ALUMINIUM





Caratteristiche Tecniche

- Profilo e coperchio in Alluminio
- Accessori in Abs
- Apertura con attrezzo
- Resistenza all'urto IK08 (5J)
- Grado di protezione IP40
- Tensione nominale 750V

Technical Features

- Aluminium profile and cover
- Abs accessories
- Opening only with tool
- Mechanical protection IK 08 (5J)
- Protection degree IP40
- Nominal voltage 750V

Riferimenti a Norme

- Conforme alla norma CEI EN 50085-2-1
- La linea è conforme alla Direttiva Rohs 2 2015/863/UE
- La linea è conforme alla Direttiva B.T. 2014/35/UE

Norms Reference

- Complies with standard CEI EN 50085-2-1
- Compliant with RoHS Directive 2015/863/UE
- Compliant with the Low Voltage Directive 2014/35/UE

Marchi e Certificazioni

- Marcatura CE

Marks and Certifications

- CE marking

Colori disponibili

- Alluminio verniciato Bianco opaco RAL9016
- Alluminio verniciato Nero opaco RAL 9005
- Alluminio verniciato Cromo scuro
- Alluminio verniciato Oro opaco
- Alluminio verniciato Grigio opaco
- Alluminio verniciato Sabbia opaco
- Alluminio spazzolato e anodizzato naturale

Available colours

- Matt white painted Aluminium RAL9016
- Matt black painted Aluminium RAL9005
- Dark chrome painted Aluminium
- Matt gold painted Aluminium
- Matt grey painted Aluminium
- Matt sand painted Aluminium
- Brushed and natural anodized Aluminium

Moduli triangolari elettrificabili in Alluminio Triangular electrifiable modules of Aluminium



Articolo Item		Moduli Modules	Serie Series	Descrizione Description	A mm	B mm	C mm
	MT102IT.VNM	4	BTicino LivingLight	Modulo nero opaco e cornici trasparenti	80	85	145
	MA102IT.VNM	4	AVE 44	Matt black module and transparent frames			
	MF102IT.VNM	2	45x45 Mosaic				
	MT102.VNM	4	BTicino LivingLight	Modulo nero opaco e cornici nere			
	MA102.VNM	4	AVE 44	Matt black module and black frames			
	MF102.VNM	2	45x45 Mosaic				
	MT102IT.V3M	4	BTicino LivingLight	Modulo bianco opaco e cornici trasparenti			
	MA102IT.V3M	4	AVE 44	Matt white module and transparent frames			
	MF102IT.V3M	2	45x45 Mosaic				
	MT102.V3M	4	BTicino LivingLight	Modulo bianco opaco e cornici bianche			
	MA102.V3M	4	AVE 44	Matt white module and white frames			
	MF102.V3M	2	45x45 Mosaic				
	MT102IT.VGA	4	BTicino LivingLight	Modulo grigio alluminio e cornici trasparenti			
	MA102IT.VGA	4	AVE 44	Aluminium grey module and transparent frames			
	MF102IT.VGA	2	45x45 Mosaic				
NEW 	MT102IT.KOR	4	BTicino LivingLight	Modulo corten e cornici trasparenti			
	MA102IT.KOR	4	AVE 44	Korten module and transparent frames			
	MF102IT.KOR	2	45x45 Mosaic				
NEW 	MT102IT.VOS	4	BTicino LivingLight	Modulo oro opaco e cornici trasparenti			
	MA102IT.VOS	4	AVE 44	Matt gold module and transparent frames			
	MF102IT.VOS	2	45x45 Mosaic				
NEW 	MT102IT.SOP	4	BTicino LivingLight	Modulo sabbia opaco e cornici trasparenti			
	MA102IT.SOP	4	AVE 44	Matt sand module and transparent frames			
	MF102IT.SOP	2	45x45 Mosaic				
	MT102.ANN	4	BTicino LivingLight	Modulo alluminio e accessori neri			
	MA102.ANN	4	AVE 44	Aluminium module and black accessories			
	MF102.ANN	2	45x45 Mosaic				

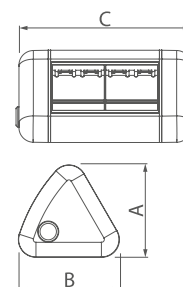

Su richiesta sono disponibili moduli con dimensioni, configurazioni e colorazioni personalizzate

Moduli triangolari elettrificabili in Alluminio Triangular electrifiable modules of Aluminium





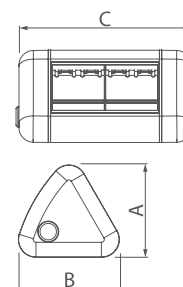

Articolo Item		Moduli Modules	Serie Series	Descrizione Description	A mm	B mm	C mm
	MT103IT.VNM	6	BTicino LivingLight	Modulo nero opaco e cornici trasparenti	80	85	190
	MA103IT.VNM	6	AVE 44	Matt black module and transparent frames			
	MF103IT.VNM	3	45x45 Mosaic				
	MT103.VNM	6	BTicino LivingLight	Modulo nero opaco e cornici nere			
	MA103.VNM	6	AVE 44	Matt black module and black frames			
	MF103.VNM	3	45x45 Mosaic				
	MT103IT.V3M	6	BTicino LivingLight	Modulo bianco opaco e cornici trasparenti			
	MA103IT.V3M	6	AVE 44	Matt white module and transparent frames			
	MF103IT.V3M	3	45x45 Mosaic				
	MT103.V3M	6	BTicino LivingLight	Modulo bianco opaco e cornici bianche			
	MA103.V3M	6	AVE 44	Matt white module and white frames			
	MF103.V3M	3	45x45 Mosaic				
	MT103IT.VGA	6	BTicino LivingLight	Modulo grigio alluminio e cornici trasparenti			
	MA103IT.VGA	6	AVE 44	Aluminium grey module and transparent frames			
	MF103IT.VGA	3	45x45 Mosaic				
	MT103IT.KOR	6	BTicino LivingLight	Modulo corten e cornici trasparenti			
	MA103IT.KOR	6	AVE 44	Korten module and transparent frames			
	MF103IT.KOR	3	45x45 Mosaic				
	MT103IT.VOS	6	BTicino LivingLight	Modulo oro opaco e cornici trasparenti			
	MA103IT.VOS	6	AVE 44	Matt gold module and transparent frames			
	MF103IT.VOS	3	45x45 Mosaic				
	MT103IT.SOP	6	BTicino LivingLight	Modulo sabbia opaco e cornici trasparenti			
	MA103IT.SOP	6	AVE 44	Matt sand module and transparent frames			
	MF103IT.SOP	3	45x45 Mosaic				
	MT102.ANN	6	BTicino LivingLight	Modulo alluminio e accessori neri			
	MA102.ANN	6	AVE 44	Aluminium module and black accessories			
	MF102.ANN	3	45x45 Mosaic				

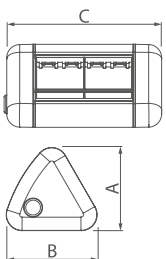

On request are available modules with customizable dimensions, configuration and colours

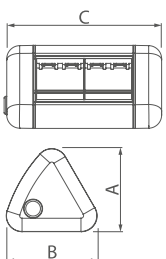

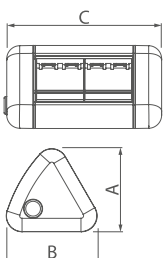

Moduli triangolari elettrificati in alluminio Wired triangular modules of aluminium

Articolo Item	Descrizione Description	A mm	B mm	C mm
MT103.4S.VNM	Modulo nero, cablato con: 2 prese MULTI (2 Schuko o 4 bipasso), 1 presa bipasso, 2 prese di carica USB (A+C), Cavo di alimentazione lunghezza 1,5 metri con presa schuko	80	85	190
	Black module, wired with: 2 MULTI-sockets (2 Schuko or 4 bipasso), 1 socket bipasso, 2 USB sockets (A+C), Power cable length 1,5 meters with schuko plug			
MT103.4S.V3M	Modulo bianco, cablato con: 2 prese MULTI (2 Schuko o 4 bipasso), 1 presa bipasso, 2 prese di carica USB (A+C), Cavo di alimentazione lunghezza 1,5 metri con presa schuko	80	85	190
	White module, wired with: 2 MULTI-sockets (2 Schuko or 4 bipasso), 1 socket bipasso, 2 USB sockets (A+C), Power cable length 1,5 meters with schuko plug			
MT103.4S.VGA	Modulo grigio alluminio, cablato con: 2 prese MULTI (2 Schuko o 4 bipasso), 1 presa bipasso, 2 prese di carica USB (A+C), Cavo di alimentazione lunghezza 1,5 metri con presa schuko	80	85	190
	Aluminium grey module, wired with: 2 MULTI-sockets (2 Schuko or 4 bipasso), 1 socket bipasso, 2 USB sockets (A+C), Power cable length 1,5 meters with schuko plug			

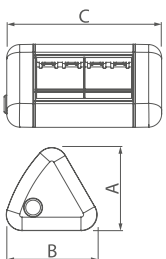

Su richiesta sono disponibili moduli con dimensioni, configurazioni e colorazioni personalizzate

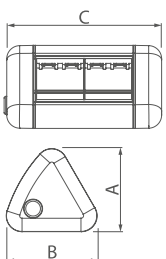
Moduli triangolari elettrificati in alluminio Wired triangular modules of aluminium

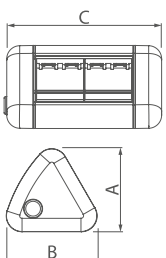
Articolo Item	Descrizione Description	A mm	B mm	C mm
MT103.SU.VNM	Modulo nero, cablato con: 2 prese MULTI (2 Schuko o 4 bipasso), 1 interruttore 2P, 2 prese di carica USB (A+C), Cavo di alimentazione lunghezza 1,5 metri con presa schuko	80	85	190
	Black module, wired with: 2 MULTI-sockets (2 Schuko or 4 bipasso), 1 switch 2P, 2 USB sockets (A+C), Power cable length 1,5 meters with schuko plug			
MT103.SU.V3M	Modulo bianco, cablato con: 2 prese MULTI (2 Schuko o 4 bipasso), 1 interruttore 2P, 2 prese di carica USB (A+C), Cavo di alimentazione lunghezza 1,5 metri con presa schuko	80	85	190
	White module, wired with: 2 MULTI-sockets (2 Schuko or 4 bipasso), 1 switch 2P, 2 USB sockets (A+C), Power cable length 1,5 meters with schuko plug			
MT103.SU.VGA	Modulo grigio alluminio, cablato con: 2 prese MULTI (2 Schuko o 4 bipasso), 1 interruttore 2P, 2 prese di carica USB (A+C), Cavo di alimentazione lunghezza 1,5 metri con presa schuko	80	85	190
	Aluminium grey module, wired with: 2 MULTI-sockets (2 Schuko or 4 bipasso), 1 switch 2P, 2 USB sockets (A+C), Power cable length 1,5 meters with schuko plug			



On request are available modules with customizable dimensions, configuration and colours

Componenti singoli per la personalizzazione Single components for the customization

Articolo Item	Descrizione Description
A	MW9090.VNM
	MW9090.V3M
	MW9090.AN
	MW9090.VGA
Profilo modulo in ALLUMINIO Aluminium module profile	
B	MW45.VNM
	MW45.V3M
Coperchio in ALLUMINIO Aluminium cover	
C	MTE.2
	MTE.3
	MTE.2T
	MTE.3T
	MTE.VGA
Tappi laterali Side caps	
D	ML4
	ML6
	MA4
	MA6
	MF4
	MF6
Mostrine autoportanti per colori e info tecniche vedere pagina 157 Self-supporting frames for colours and technical info see page 157	

Morsetto di terra Earthing clamp

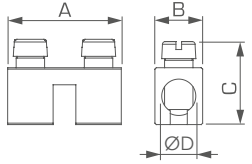
F	Articolo Item			
BMT65				
				
A	B	C	ØD	
mm	mm	mm	mm	
20	8,5	15,5	6	
				

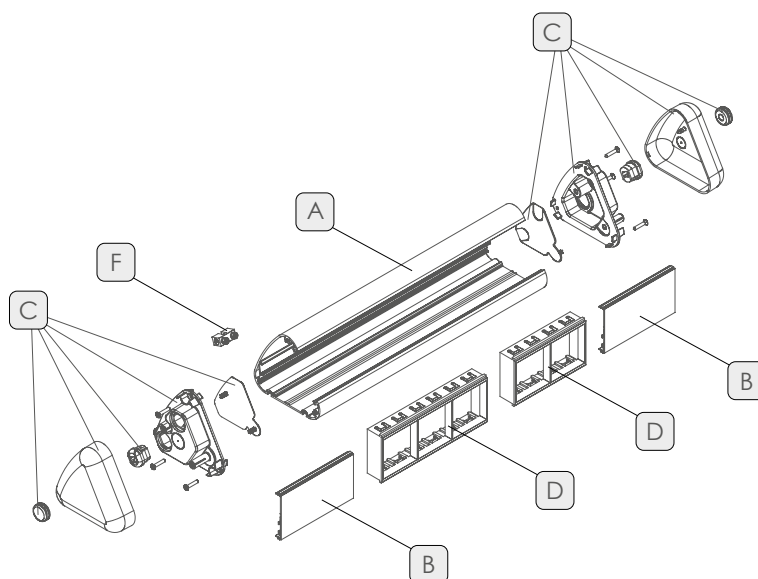

Mostrina autoportante 4 moduli BTicino Living Light Self-supporting frame 4 modules BTicino Living Light

Articolo Item		A mm	B mm	C mm
ML4.3	Bianco White	20,4	92,5	54
ML4.2	Nero Black			
ML4.T	Trasparente Transparent			

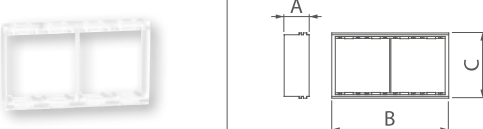

Mostrina autoportante 6 moduli BTicino Living Light Self-supporting frame 6 modules BTicino Living Light

Articolo Item		A mm	B mm	C mm
ML6.3	Bianco White	20,4	137,5	54
ML6.2	Nero Black			
ML6.T	Trasparente Transparent			

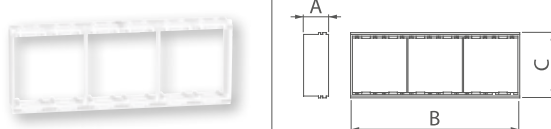

Mostrina autoportante 4 moduli Ave 44 Self-supporting frame 4 modules Ave 44

Articolo Item		A mm	B mm	C mm
MA4.3	Bianco White	19	92,5	54
MA4.2	Nero Black			
MA4.T	Trasparente Transparent			

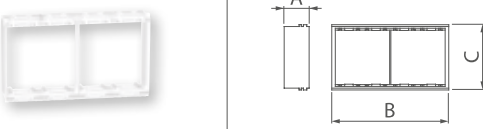

Mostrina autoportante 6 moduli Ave 44 Self-supporting frame 6 modules Ave 44

Articolo Item		A mm	B mm	C mm
MA6.3	Bianco White	19	137,5	54
MA6.2	Nero Black			
MA6.T	Trasparente Transparent			

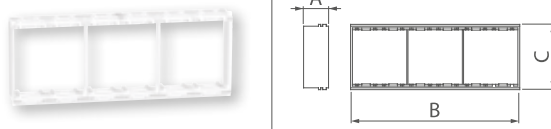

Mostrina autoportante 2 moduli 45x45 Mosaic Self-supporting frame 2 modules 45x45 Mosaic

Articolo Item		A mm	B mm	C mm
MR4.3	Bianco White	19	92,5	54
MR4.2	Nero Black			
MR4.T	Trasparente Transparent			



Mostrina autoportante 3 moduli 45x45 Mosaic Self-supporting frame 3 modules 45x45 Mosaic

Articolo Item		A mm	B mm	C mm
MR6.3	Bianco White	19	137,5	54
MR6.2	Nero Black			
MR6.T	Trasparente Transparent			

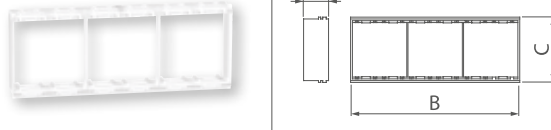

Tappi laterali
Cover caps

Articolo Item	Colori Colours			
MTE.3	Tappo bianco e cornice bianca White cap and white frame			
MTE.2	Tappo nero cornice nera Black cap and black frame			
MTE.3T	Tappo bianco e cornice trasparente White cap and transparent frame			
MTE.2T	Tappo nero e cornice trasparente Black cap and transparent frame			
MTE.VGA	Tappo alluminio e cornice trasparente Aluminium cap and transparent frame			
		A mm	B mm	C mm
		27	86	79

Kit LED per illuminazione interna torrette
LED kit for internal illumination turrets

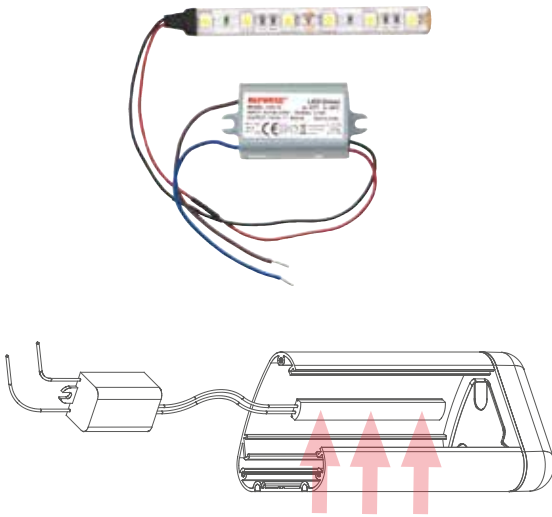
Articolo Item	Descrizione Description
MTLED	Striscia LED lunghezza 110 mm Led strip length 110 mm
MTRLED	Striscia LED lunghezza 250 mm Led strip length 250 mm
<ul style="list-style-type: none"> • Dimensione driver 55x30x30 mm; • La striscia LED è dotata di biadesivo; • Per illuminazione LED utilizzare le mostrine trasparenti e i terminali con cornice trasparente <p>Driver dimension 55x30x30 mm;</p> <ul style="list-style-type: none"> • The LED strip is equipped with adhesive; • For LED lighting use the transparent frames and end piece with transparent frame 	
	

Sezione del profilo e quantità conduttori inseribili al suo interno
Section and quantity of conductors that can be inserted

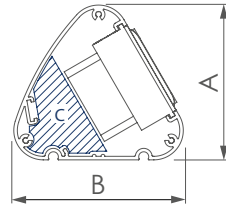
MW9090		Numero di conduttori tripolari inseribili nel profilo Number of tripolar cables insertable in the profile					
A mm	80	Area	3x1,5 mm ²	3x2,5 mm ²	3x4 mm ²	3x6 mm ²	
B mm	85	C	4	3	3	2	

Sistemi di fissaggio per moduli TRIWER Fixing systems for TRIWER modules

Articolo Item	Descrizione Description		
1 CTRIWER	<p>IN APPOGGIO Inserendo a pressione la corda in gomma antiscivolo sul fondo del profilo MW9090. Rotolo da 10 m</p> <p>SUPPORTED By pressing the non-slip rubber cord onto the bottom of the MW9090 profile. 10 m roll</p>		
2 MNB5	<p>CON NASTRO BI-ADESIVO Usando il nastro adesivo ad altissima tenuta si può fissare il modulo sopra o sotto scrivania. Rotolo da 5 m</p> <p>WITH ADHESIVE TAPE Using the extra-strong adhesive tape, the module can be attached above or below the desk. 5 m roll</p>		
3	<p>MST.V3M</p> <p>CON SUPPORTO A MORSETTO Usando il supporto a morsetto che si può fissare, senza forare, sul bordo di una scrivania con spessore max 3,5 cm</p>	 Bianco White	
	<p>MST.VNM</p> <p>WITH CLAMP SUPPORT Using the clamp support, which can be fixed, without drilling, to the edge of a desk with a maximum thickness of 3.5 cm.</p>	 Nero Black	
4	<p>MSU.V3M</p> <p>CON SUPPORTI A VITE Usando i supporti in acciaio INOX verniciato che si possono fissare, forando, sopra o sotto il piano di appoggio. Forniti con 2 pressacavi per cavi con diametro da 6 mm a 12 mm.</p>	 Bianco White	
	<p>MST.VNM</p> <p>WITH SCREW-ON SUPPORTS Using painted stainless steel supports that can be fixed by drilling holes above or below the support surface. Supplied with two cable glands for cables with diameters ranging from 6 mm to 12 mm.</p>	 Nero Black	