



SPACE45

Sistema di canali di distribuzione per moduli 45

Distribution trunkings for devices module 45



Caratteristiche Tecniche Technical Features

- Canale in PVC ed accessori in ABS
- Trunking of PVC and accessories of ABS
- Canale lunghezza standard 2 metri
- Trunking standard length 2 meters
- Apertura coperchio con attrezzo
- Cover disassembling with tool
- Resistenza all'urto IK 08 (5J)
- Mechanical protection IK 08 (5J)
- Grado di protezione IP40
- Protection degree IP40

Caratteristiche di Impiego Use Features

- Canali porta cavi e porta apparecchi adatti per applicazioni a parete e battiscopa
- Cable trunkings and distribution trunkings system for wall and skirting installations

Riferimenti a Norme Norms Reference

- La linea è conforme alla norma CEI EN 50085-2-1
- The system complied to CEI EN 50085-2-1
- La linea è conforme alla Direttiva Rohs 2 2015/863/EU
- The system complied to Rohs 2 2015/863/EU
- La linea è conforme alla Direttiva B.T. 2009/95/CE
- The system complied to L.V.D. 2009/95/CE

Marchi e Certificazioni Marks and certifications

- Marcatura CE
- CE Marking

Colori disponibili Available colours





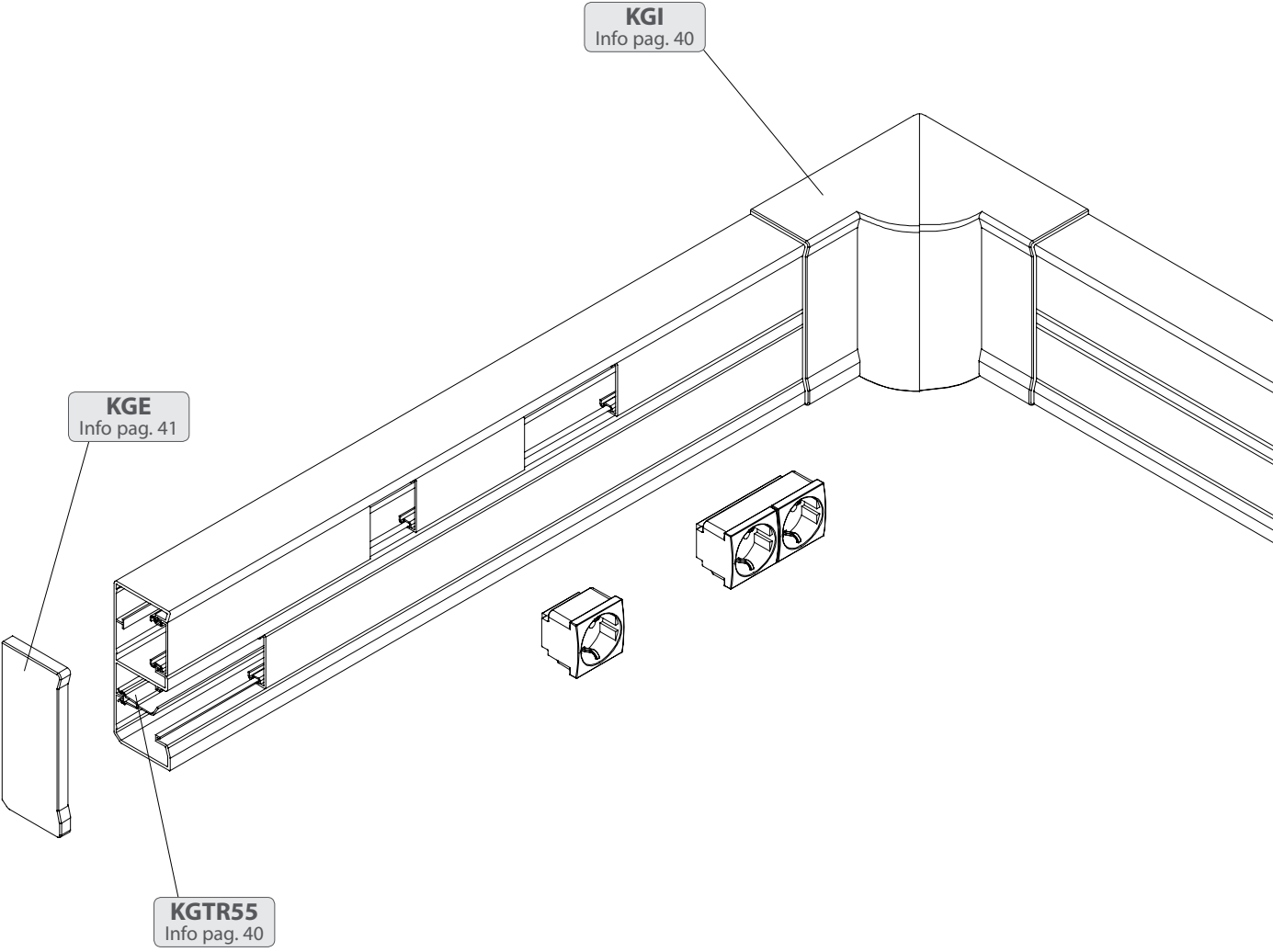

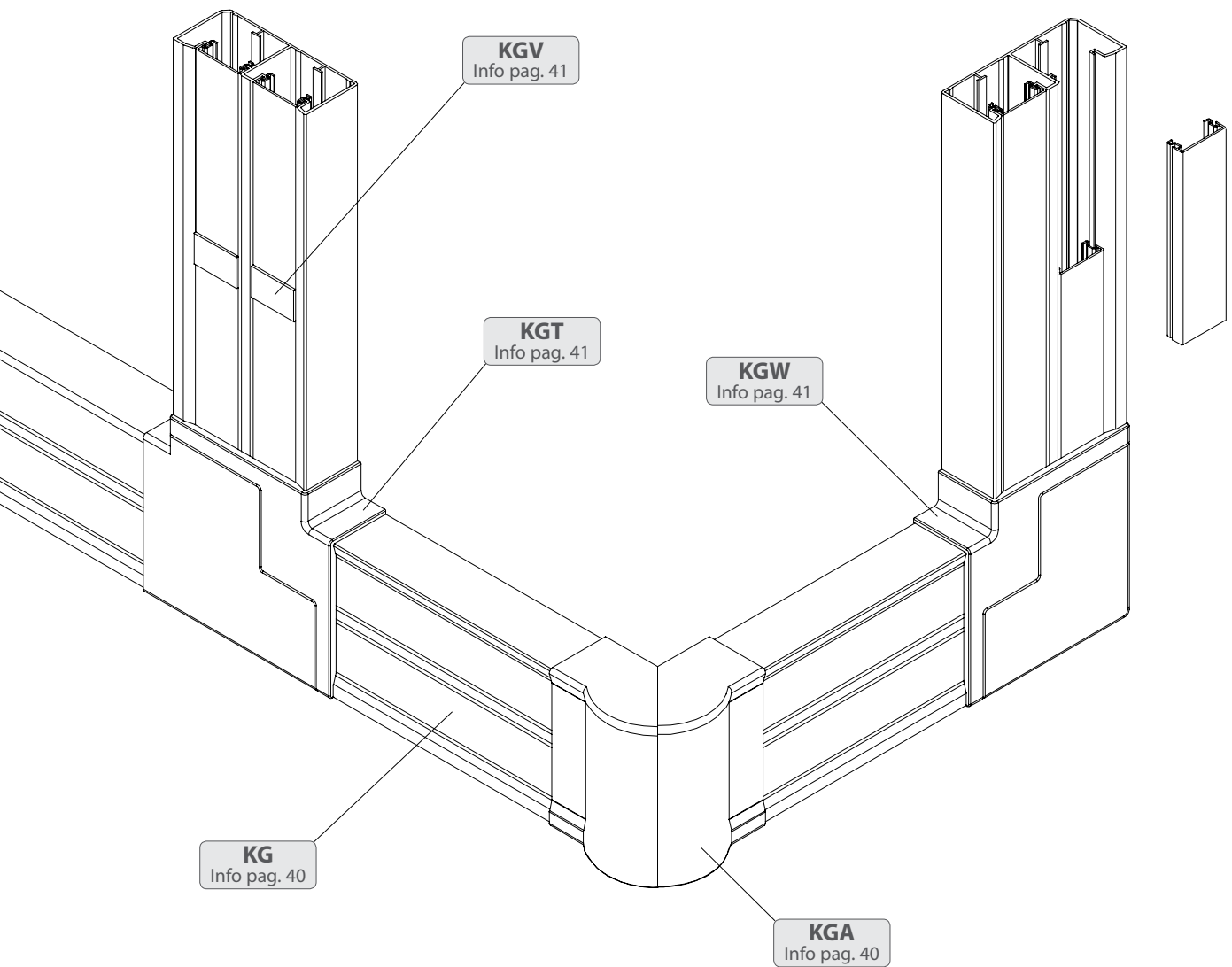
- Bianco RAL9010
- White RAL9010
- Alluminio anodizzato
- Anodized aluminium





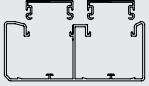
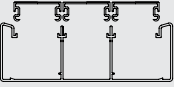
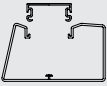
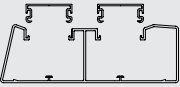

Canale per apparecchi con modulo 45 mm, in PVC
Trunking for devices modules 45 mm, of PVC

					
Dimensioni Dimensions	Canale Trunking	Separatore Separator	Angolo interno variabile Variable internal angle	Angolo esterno variabile Variable external angle	
 54x54mm / 2 2.160 mm ²	KG5555.3	KGTR55			
 85x56 mm / 2 3.690 mm ²	KG5585.3	KGTR55	KGI5585.3	KGA5585.3	
 134x56 mm / 4 5.330 mm ²	KG55135-2.3	KGTR55	KGI55135.3	KGA55135.3	
 162x56 mm / 3 5.510 mm ²	KG55165-3.3		KGI55165.3	KGA55165.3	
 105x56 mm / 2 4.694 mm ²	KG55105.3	KGTR55	KGI55105.3	KGA55105.3	
 175x56 mm / 4 7.960 mm ²	KG55175-2.3	KGTR55	KGI55175.3	KGA55175.3	

Canale per apparecchi con modulo 45 mm, in ALLUMINIO
Trunking for devices modules 45 mm, of ALUMINIUM

					
Dimensioni/Divisibile in scomparti Dimensions/Compartments option	Canale Trunking	Separatore Separator	Angolo interno variabile Variable internal angle	Angolo esterno variabile Variable external angle	
 85x56 mm / 2 3.690 mm ²	KG5585A	KGTR55	KGI5585.AL	KGA5585.AL	
 134x56 mm / 4 5.330 mm ²	KG55135-2A	KGTR55	KGI55135.AL	KGA55135.AL	
 162x56 mm / 3 5.510 mm ²	KG55165-3A		KGI55165.AL	KGA55165.AL	

			
Curva piana Flat angle	Deviazione a T T-Joint	Terminale End piece	Coprigiunzione Cover joint
		KGE5555.3	KGV45.3
KGW5585.3	KGT5585.3	KGE5585.3	KGV45.3
KGW55135.3	KGT55135.3	KGE55135.3	KGV45.3
KGW55165.3	KGT55165.3	KGE55165.3	KGV45.3
KGW55105.3	KGT55105.3	KGE55105.3	KGV45.3
KGW55175.3	KGT55175.3	KGE55175.3	KGV45.3

		
Curva piana Flat angle	Deviazione a T T-Joint	Terminale End piece
KGW5585.AL	KGT5585.AL	KGE5585.AL
KGW55135.AL	KGT55135.AL	KGE55135.AL
KGW55165.AL	KGT55165.AL	KGE55165.AL