



KAPPA45

Sistema di canali di distribuzione per moduli 45

Distribution trunkings for devices module 45



Caratteristiche Tecniche Technical Features

- Canale in PVC ed accessori in ABS
- Trunking of PVC and accessories of ABS
- Canale lunghezza standard 2 metri
- Trunking standard length 2 meters
- Apertura coperchio con attrezzo
- Cover disassembling with tool
- Resistenza all'urto IK 08 (5J)
- Mechanical protection IK 08 (5J)
- Grado di protezione IP40
- Protection degree IP40

Caratteristiche di Impiego Use Features

- Canali porta cavi e porta apparecchi adatti per applicazioni a parete e battiscopa
- Cable trunkings and distribution trunkings system for wall and skirting installations

Riferimenti a Norme Norms Reference

- La linea è conforme alla norma CEI EN 50085-2-1
- The system complied to CEI EN 50085-2-1
- La linea è conforme alla Direttiva Rohs 2 2011/65/CE
- The system complied to Rohs 2 2011/65/CE
- La linea è conforme alla Direttiva B.T. 2009/95/CE
- The system complied to L.V.D. 2009/95/CE

Marchi e Certificazioni Marks and certifications

- Marcatura CE
- CE Marking

Colori disponibili Available colours

- Bianco RAL9010
- White RAL9010
- Alluminio anodizzato
- Anodized aluminium



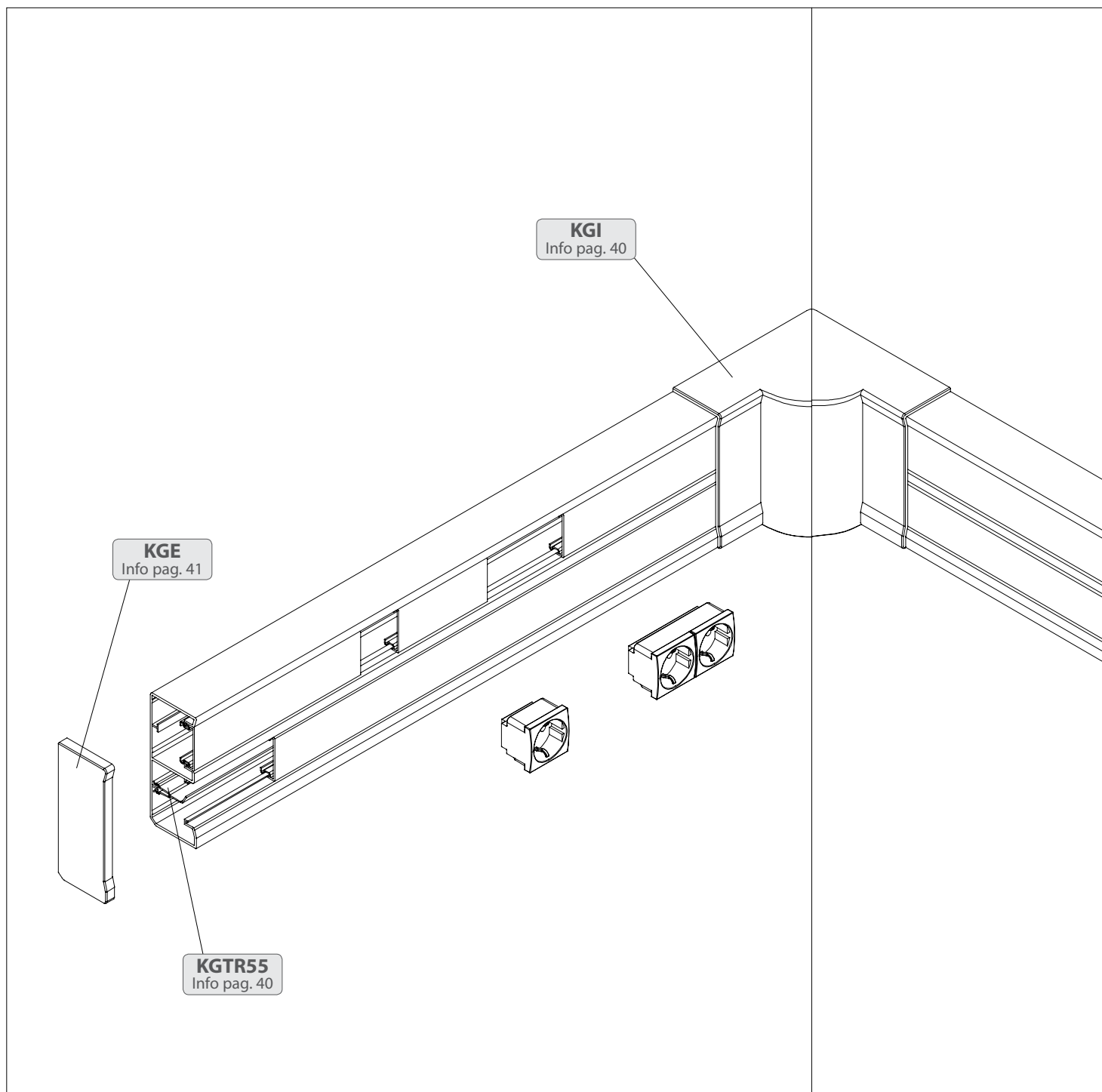

Montaggio dei moduli a scatto

I moduli vengono montati a scatto direttamente sul canale, questo permette di risparmiare telaio e placca ma soprattutto consente un notevole risparmio di tempo.

Click mounting for devices

The devices are mounted with click system on the trunking, this allows to save time and money.

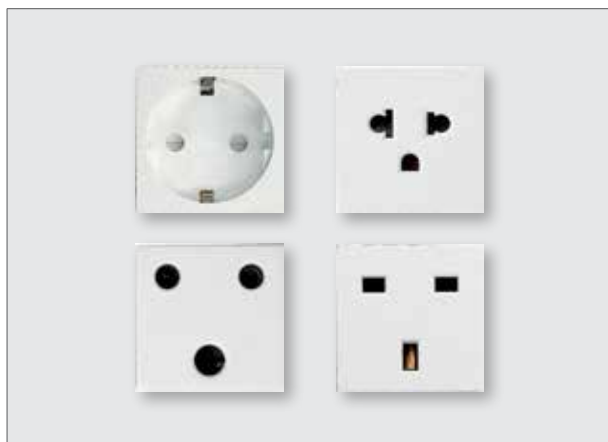
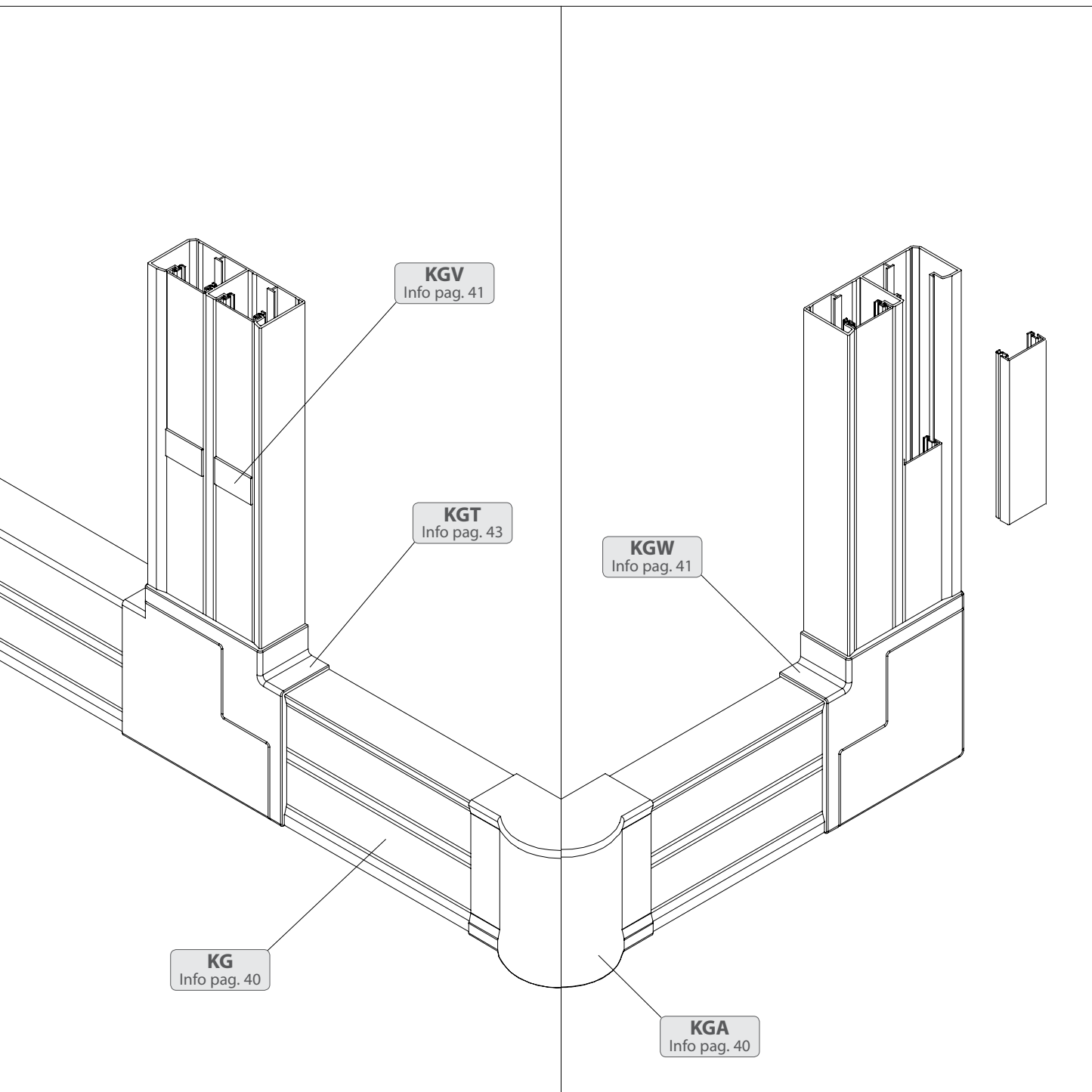







Apparecchi modulo 45

E' disponibile un'ampia gamma di moduli 45, vedi pagina 42-43.

Devices module 45

A big range of devices module 45 is available, see page 42-43.

Canale per apparecchi con modulo 45 mm, in PVC
Trunking for devices modules 45 mm, of PVC

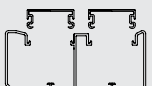
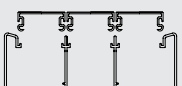
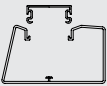
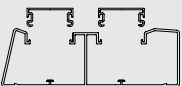
							
Dimensioni Dimensions	Canale Trunking	Separatore Separator	Angolo interno variabile Variable internal angle	Angolo esterno variabile Variable external angle			
 54x54mm /2	KG5555.3	KGTR55					
 85x56 mm /2	KG5585.3	KGTR55	KGI5585.3	KGA5585.3			
 134x56 mm /4	KG55135-2.3	KGTR55	KGI55135.3	KGA55135.3			
 162x56 mm /3	KG55165-3.3		KGI55165.3	KGA55165.3			
 105x56 mm /2	KG55105.3	KGTR55	KGI55105.3	KGA55105.3			
 175x56 mm /4	KG55175-2.3	KGTR55	KGI55175.3	KGA55175.3			



Canale per apparecchi con modulo 45 mm, in ALLUMINIO
Trunking for devices modules 45 mm, of ALUMINIUM

							
Dimensioni/Divisibile in scomparti Dimensions/Compartments option	Canale Trunking	Separatore Separator	Angolo interno variabile Variable internal angle	Angolo esterno variabile Variable external angle			
 85x56 mm /2	KG5585A	KGTR55	KGI5585.AL	KGA5585.AL			
 134x56 mm /4	KG55135-2A	KGTR55	KGI55135.AL	KGA55135.AL			
 162x56 mm /3	KG55165-3A		KGI55165.AL	KGA55165.AL			





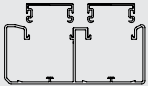
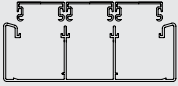
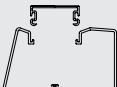
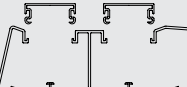

			
Curva piana Flat angle	Deviazione a T T-Joint	Terminale End piece	Coprigiunzione Cover joint
		KGE5555.3	KGV45.3
KGW5585.3	KGT5585.3	KGE5585.3	KGV45.3
KGW55135.3	KGT55135.3	KGE55135.3	KGV45.3
KGW55165.3	KGT55165.3	KGE55165.3	KGV45.3
KGW55105.3	KGT55105.3	KGE55105.3	KGV45.3
KGW55175.3	KGT55175.3	KGE55175.3	KGV45.3

		
Curva piana Flat angle	Deviazione a T T-Joint	Terminale End piece
KGW5585.AL	KGT5585.AL	KGE5585.AL
KGW55135.AL	KGT55135.AL	KGE55135.AL
KGW55165.AL	KGT55165.AL	KGE55165.AL

Dati tecnici dei canali della linea Kappa 45
Kappa 45 line trunkings technical features

Articolo Item		Scomparti Compartments	Divisibilità Divisibility	Dimensione bxh Dimensions bxh	Sezione scomparti mm ² Compartments cross section mm ²			
					1	2	3	TOT
	KG5555	1	2	54 x 54 mm	2.160			2.160
	KG5585	1	2	85 x 56 mm	3.690			3.690
	KG55135	2	4	134 x 56 mm	2.610	2.720		5.330
	KG55165	3	-	162 x 56 mm	1.890	1.730	1.890	5.510
	KG55105	1	2	105 x 56 mm	4.694			4.694
	KG55175	2	4	175 x 56 mm	3.584	4.376		7.960

Moduli 45
Modules 45

Articolo Item		Colore Colour	Moduli occupati Occupied modules	Descrizione Description
	KPS2PT.W	Bianco White	2	Presa Schuko 2P+T - 16A - 250V Schuko socket 2P+T - 16A - 250V
	KPS2PT.R	Rosso Red		
	KIT2PT.W	Bianco White	1	Presa Bipasso Italiana 2P - 16A - 250V Combined Italian socket 2P - 16A - 250V
	KSF2PT.W	Bianco White	2	Presa Schuko Francese 2P+T - 16A - 250V Schuko Franch socket 2P+T - 16A - 250V
	KPE2PT.W	Bianco White	2	Presa Inglese BS1363 2P+T - 13A - 250V British socket BS1363 2P+T - 13A - 250V
	KSA2PT.W	Bianco White	2	Presa Sudafricana 2P+T - 20A - 250V South-Africa socket 2P+T - 20A - 250V
	KEA2PT.W	Bianco White	2	Presa Euroamericana 2P+T - 16A - 250V Euro-american socket 2P+T - 16A - 250V

Articolo Item		Colore Colour	Moduli occupati Occupied modules	Descrizione Description
	KEA2P.W	Bianco White	1	Presa Euroamericana 2P - 16A - 250V Euro-american socket 2P - 16A - 250V
	KMU2PT.W	Bianco White	2	Presa Multifunzione 2P - 16A - 250V Multifunction socket 2P - 16A - 250V
	KPRJ5.W (Cat5e)	Bianco White	1	Presa RJ45 RJ45 socket
	KPRJ6.W (Cat6)			
	KRJ11.W	Bianco White	1	Presa telefonica RJ11 - 6 poli - 4 contatti RJ11 Telephone socket - 6 poles - 4 contacts
	KTVF.W	Bianco White	1	Presa coassiale TV femmina TV coaxial outlet female
	KHDM.W	Bianco White	1	Presa HDMI HDMI socket
	KUSB.W	Bianco White	1	Presa USB USB socket
	KUSBC.W	Bianco White	1	Caricatore USB USB charger
	KRCA.W	Bianco White	1	Presa audio RCA RCA audio socket
	KIN1D.W	Bianco White	2	Interruttore 10A, 250V 1 way switch 10A, 250V
	KIN1.W	Bianco White	1	Interruttore 16A 1 way switch 16A
	KIN2.W	Bianco White	1	Deviatore 16A 2 ways switch 16A
	KTCF1.W	Bianco White	1	Tappo copriforo Empty plate